



## Liberty

VOYAGER

**“Beautiful solid US oak table with elegant sharknose profile, this table is a perfect centrepiece with zero impediment to seating. 100% Australian made”**

**Colours:** Timber available in Solid US Oak and Solid Tasmanian Oak, lots of stain options including colour matching, as well as brushed or clean finishes

**Finishes:** Steel available in a large range of powdercoat colours. A modular system of table bases is also available: egg-beater, cross-leg, spool etc.

**Warranty:** 10 year structural warranty

**Lead time:** 8 Weeks approx (Made in Melbourne)

Prices, availability, lead times, dimensions and product information listed are subject to change without notice. This document was created on 25/Jul/2019 at 08:53 AM.

# Locally Made Round Timber Tables

## Suggested Sizes & Seating

Available in sizes from 120 cm to 210 cm.

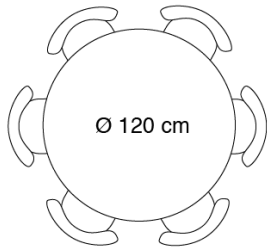

Ø 120 cm

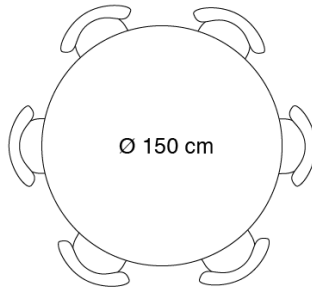

Ø 150 cm

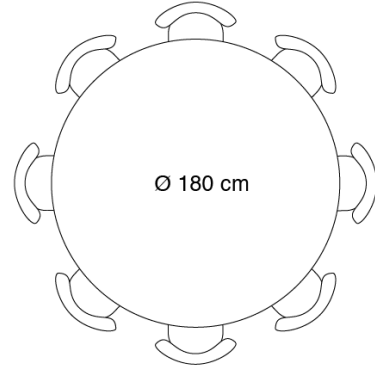

Ø 180 cm

## Table Top Edges

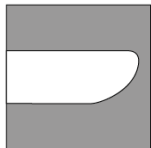

Pebble

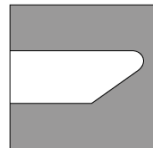

Liberty

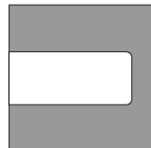

Husky

## Timber Colours

Below are our most popular stains with custom stains available on request.



Coal



Drift



Honey



Sable



Soot / Black

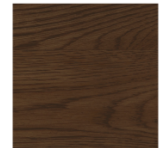

Walnut

## Timber Finishes

American Oak: Clean or Brushed

Tasmanian Oak: Clean or Rough Sawn

## Metal Bases

Powder Coated (choice of colour)  
or Stainless Steel.

Egg Beater base also available in timber.

Millennium base can support a maximum  
Ø 150 cm table top.

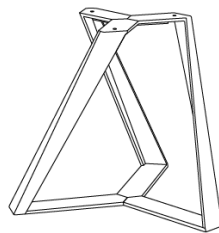

Millennium

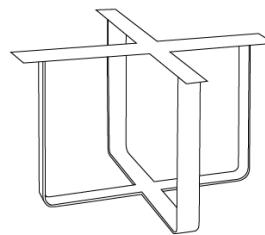

Egg Beater

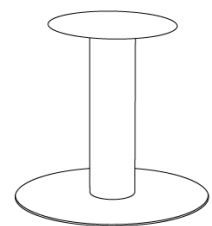

Column

Standard table height approximately 76 cm dependent on base and table top selected.

Timber colours shown indicative only due to screen and printer colour variations. Please refer to actual samples in-store.

Prices, availability, lead times, dimensions and product information listed are subject to change without notice. This document was created on 25/Jul/2019 at 08:53 AM.